

Shaft plan view

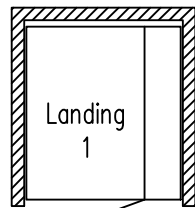

M= An additional 50 mm for clear structural opening is required.

Shaft ceiling with a light.

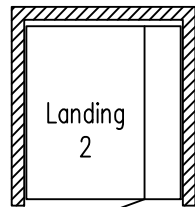
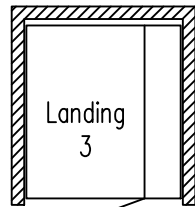
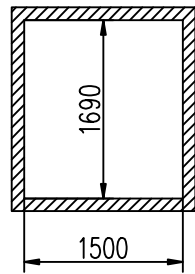
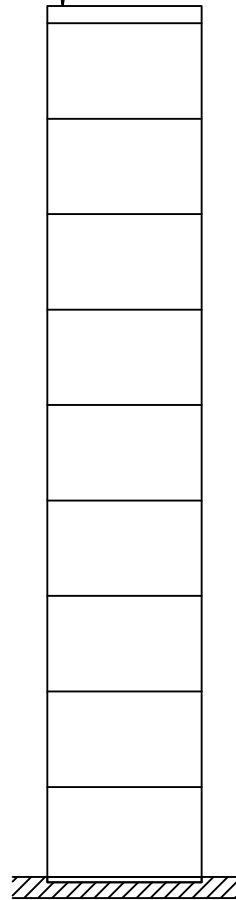

Side C

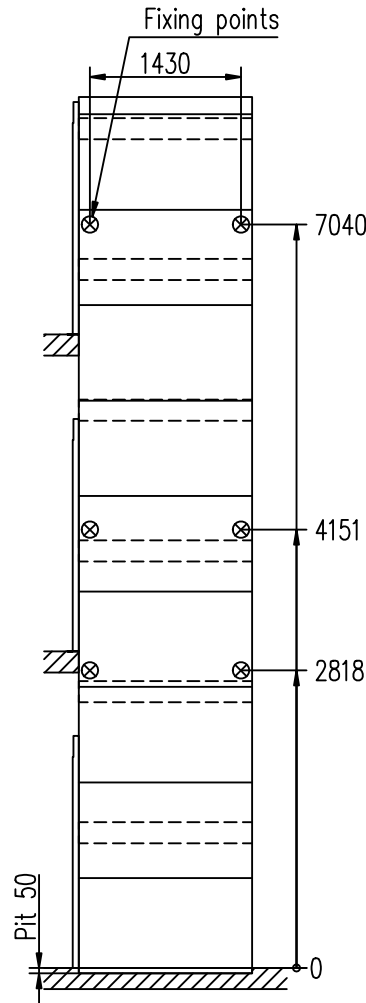

Side D

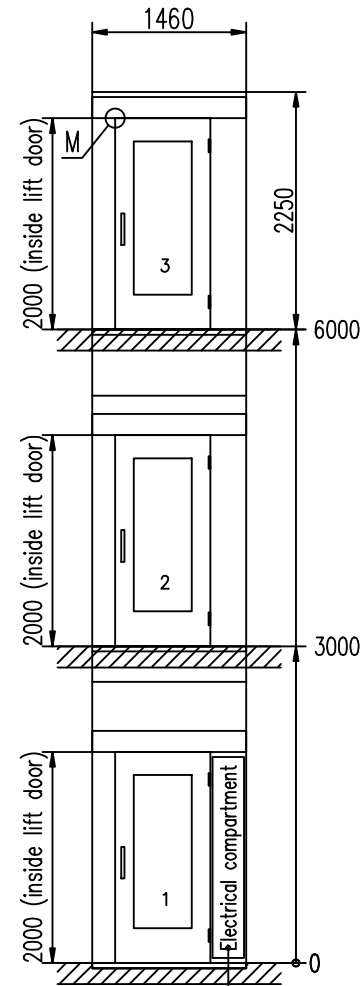

Side A

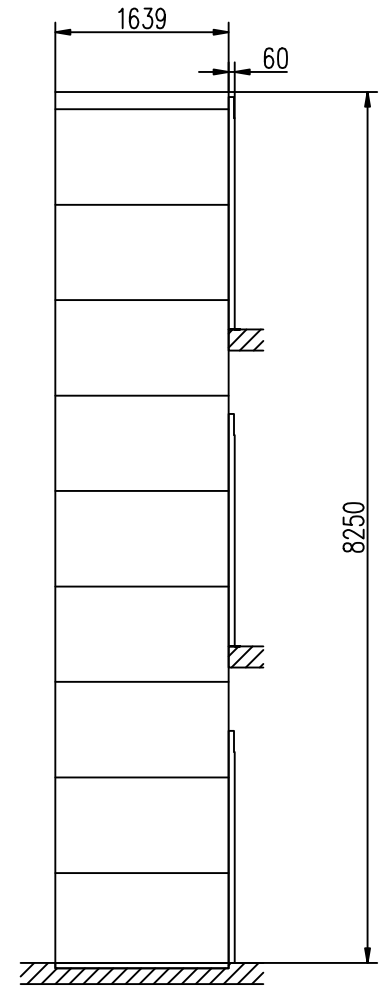

Side B

Access required for compartment cover

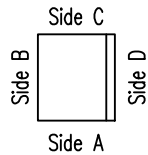

Drawn  
Constr.

Shaftwall A 5000

Scale  
1:47

File name  
108893-W

Date  
14-09-11

Dwg-nr

Sheet

1