

M= An additional 50 mm for clear structural opening is required.

Shaft plan view

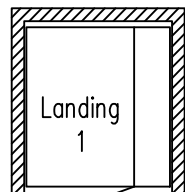

Shaft ceiling with a light.

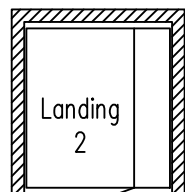
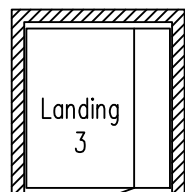
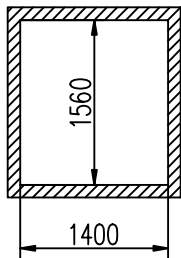
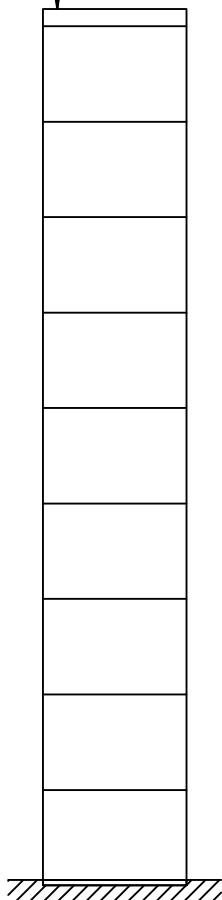

Side C

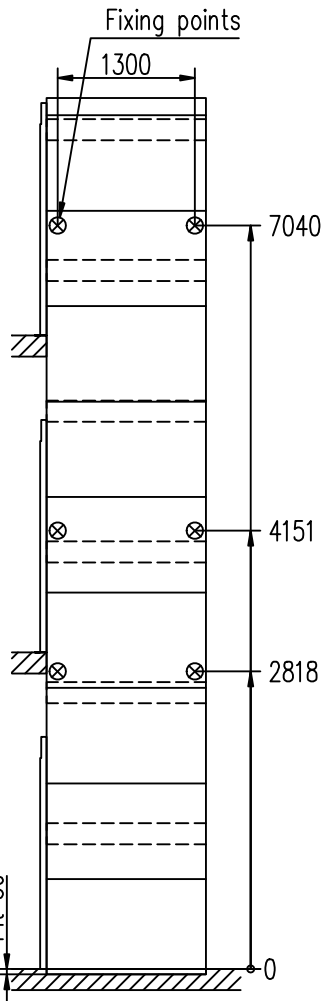

Side D

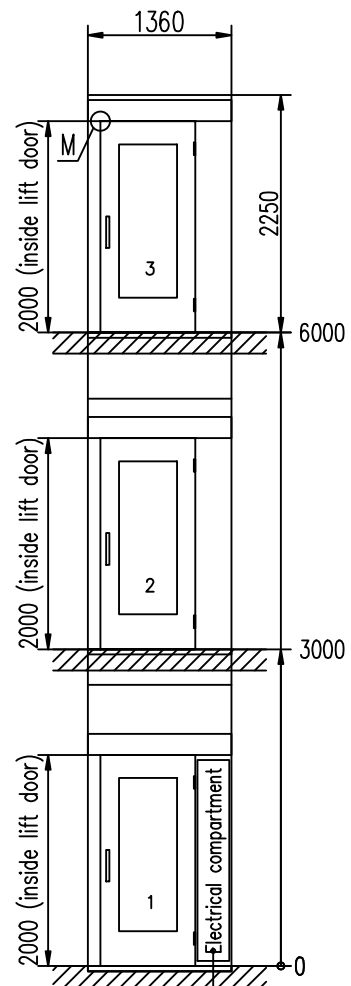

Side A

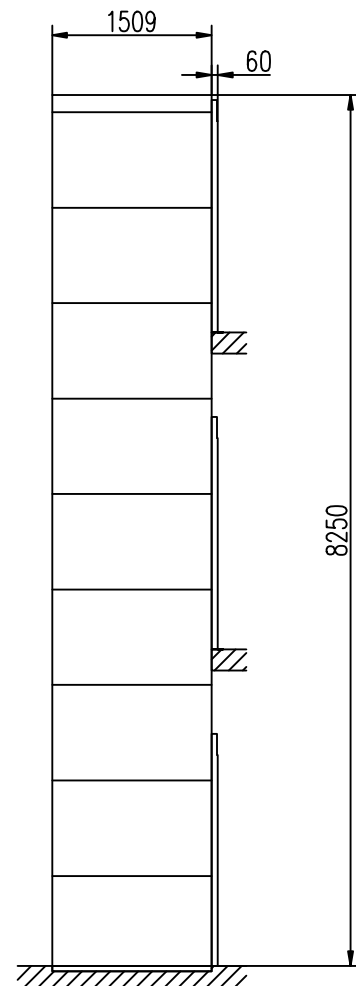

Side B

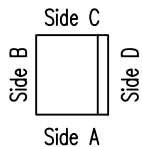

Drawn Shaftwall A 5000

Constr.

Scale	File name
1:47	108681-W
Dwg-nr	Date
	14-09-08
	Sheet
	1